

PRODUCT DESCRIPTION

- A system used to hold, fix, adjust, change, secure and block quickly
- Compact design with a simple and fast unlock with a button handle
- Safety cable to prevent its loss

APPLICATION

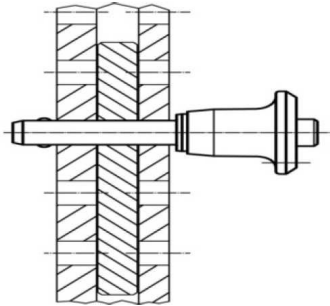

DRAWING

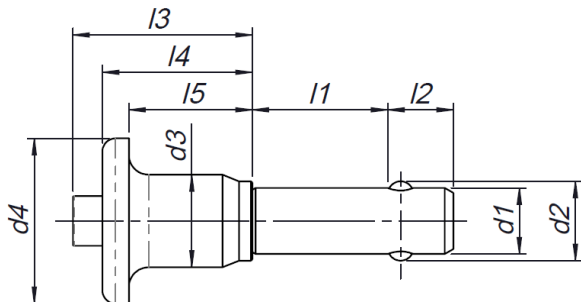

d1	l1	d2	d3	d4	l2	l3	l4	l5
10	20	12	14,1	25	9,6	27,3	22,6	18,6
-0,04 -0,08	+0,06				+1 -1			

Note: Measurements and tolerances in this table are given in mm.

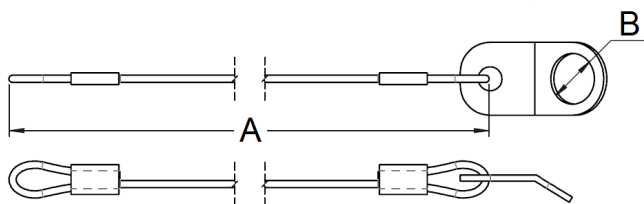

A (mm)	B (mm)	Cable thickness
170	8,5	1,2 mm

MATERIALS

- **AXIS :** Stainless steel 630 / 17-4 PH
- **HANDLE:** Aluminium 6061. The surface treatment is black cataphoresis

SPECIFICATIONS - METRIC

QRP DIA (mm)	DOUBLE SHEAR RESISTANCE Minimum (kN)*	RECOMMENDED HOLE DIAMETER (mm)	
		Maximum	Minimum
10	75	10,1	10

Note:

* Test Method Used: GB/T 13683-1192 by SGS-CSTC Standards Technical Services Co.